

TAPPI

HOLE PLUGS

TAPPI | *Hole plugs*

SOTTOTAPPI | *Protection plugs*

PUNTALI MORBIDI | *Soft caps*

TAPPI A TESTA PIANA | *Flat head caps*

CAPSULE FILETTATE | *Thread caps*

CAPSULE FILETTATE RAPIDE | *Quick thread caps*

CAPSULE FILETTATE A TENUTA
Watertight thread caps

TAPPI FILETTATI A TENUTA
Watertight thread hole plugs

TAPPI FILETTATI A TENUTA CON O-RING
Watertight thread hole plugs with o-ring

TAPPI PROTEZIONE DADI E BULLONI
Nuts and bolts protection caps

TAPPI PER FORI SU LAMIERE
Hole metal plates caps

TAPPI IN PVC PER FORI SU LAMIERE
PVC hole metal plates caps

PRESSACAVI | *Cable glands*

RONDELLA PER PRESSACAVI
Cable glands washer

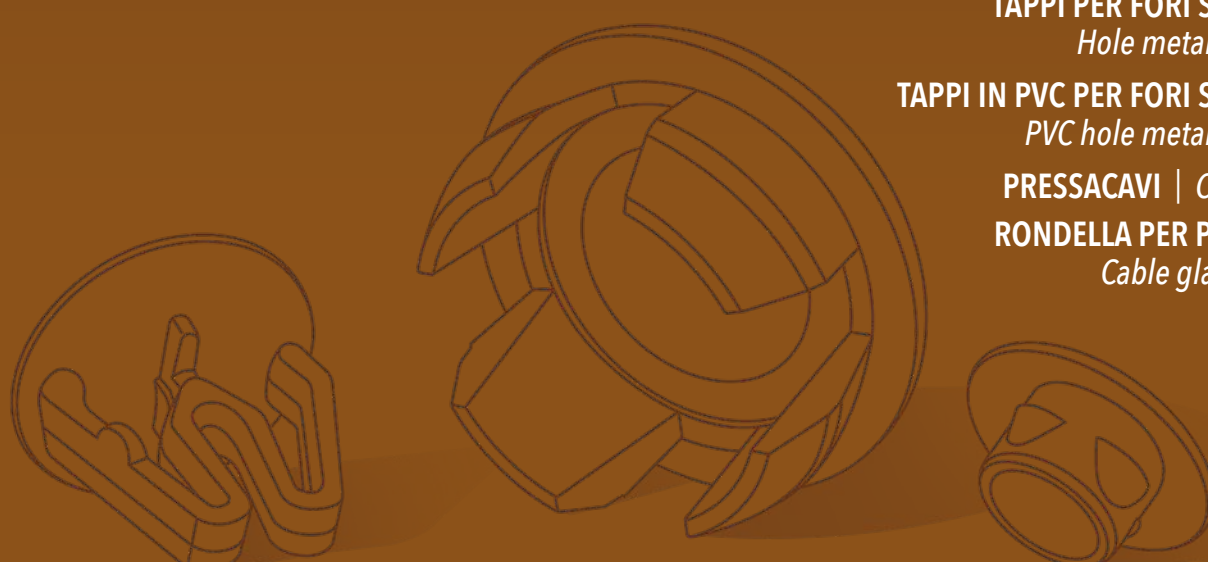

MATERIALE | MATERIAL: Nylon 66 | PA 66**COLORI STANDARD** | STANDARD COLOURS: Naturale - Nero | Natural - Black**TAPPI PER FORO VARIABILE** | Plugs for variable size hole

P/N	DIMENSIONI Sizes			PANNELLO Panel		TIPO Type
	D	H	L	Ø FORO Hole	SPESSORE Thickness	
10140.33.41	16,7	1,5	15,5	9,5 ÷ 13,5	1,0 ÷ 2,5	
10141.33.41	24,8	1,5	17,5	14,0 ÷ 21,0	1,0 ÷ 2,5	
10142.33.41	34,8	1,5	18,5	22,0 ÷ 30,0	1,0 ÷ 2,5	

TAPPI AD ALETTE | Hole plugs

P/N	DIMENSIONI Sizes			PANNELLO Panel		TIPO Type
	D	H	L	Ø FORO Hole	SPESSORE Thickness	
01048.21.11	8,0	1,5	7,0	4,0	0,5 ÷ 3,0	
01178.95.11	10,3	1,6	6,1	5,5	0,8 ÷ 1,5	
00189.21.11	10,5	1,5	7,0	6,0	0,5 ÷ 3,0	
00230.21.11	12,5	1,5	7,5	8,0	0,5 ÷ 3,0	
00214.94.11	14,5	2,0	10,0	8,0	0,5 ÷ 4,0	
00656.21.10	14,0	2,0	9,3	9,5	0,5 ÷ 4,0	
00053.91.11	25,0	2,0	11,5	19,5	1,0 ÷ 3,0	
01222.65.605A	27,0	2,5	12,5	23,0	0,7 ÷ 4,0	
00134.94.11U	31,5	2,0	8,5	25,0	0,5 ÷ 3,0	

MATERIALE | MATERIAL: Polietilene | Polyethylene

COLORI STANDARD | STANDARD COLOURS: Naturale - Nero | Natural - Black



TAPPI A CORONA CIRCOLARE TESTA PIANA | Hole plugs flat head

P/N	DIMENSIONI Sizes			PANNELLO Panel		TIPO Type
	D	H	L	Ø FORO Hole	SPESSORE Thickness	

00007.91.21

15,0

2,0

5,8

12,0

< 2,0

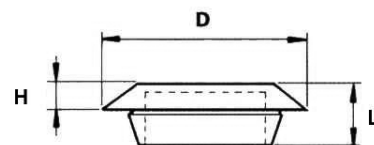

TAPPI A CORONA CIRCOLARE TESTA CONCAVA | Hole plugs depressed head

P/N	DIMENSIONI Sizes			PANNELLO Panel		TIPO Type
	D	H	L	Ø FORO Hole	SPESSORE Thickness	

02115.94.21U

45,0

4,0

8,0

32,0

0,5 ÷ 2,5

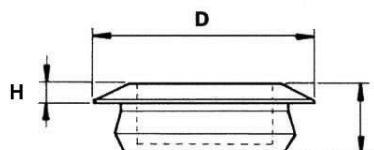

MATERIALE | MATERIAL: Nylon 66 - Polietilene | PA 66 - Polyethylene

COLORI STANDARD | STANDARD COLOURS: Naturale - Nero | Natural - Black



TAPPI A CORONA DENTATA TESTA PIANA | Plugs with retention teeth flat head

P/N	DIMENSIONI Sizes			PANNELLO Panel		TIPO Type
	D	H	L	Ø FORO Hole	SPESSORE Thickness	
01379.03.21	12,0	1,5	6,0	8,5	0,7 ÷ 1,2	
01004.03.21	18,0	3,5	9,0	10,0	1,5 ÷ 3,0	
00860.65.21	16,0	3,0	6,0	12,0	0,7 ÷ 1,3	
03775.65.11	25,2	4,5	9,0	14,0	0,6 ÷ 2,5	
02927.94.11	30,2	3,4	9,0	18,0	0,7 ÷ 2,5	
04734.65.11	30,0	3,5	10,0	20,0	1,0 ÷ 2,5	

TAPPI A CORONA DENTATA TESTA CONCAVA | Plugs with retention teeth depressed head

P/N	DIMENSIONI Sizes			PANNELLO Panel		TIPO Type
	D	H	L	Ø FORO Hole	SPESSORE Thickness	
01162.94.21U	14,5	2,1	8,5	8,5	0,7 ÷ 3,0	

TAPPI 3 | Hole plugs 3

MATERIALE | MATERIAL: Nylon 66 | PA 66

COLORI STANDARD | STANDARD COLOURS: Nero - Bianco | Black - White

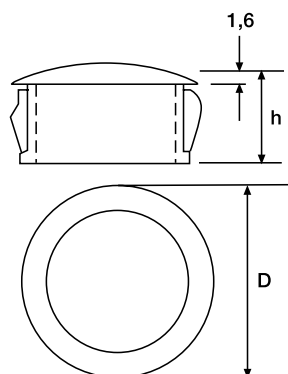

TAPPI STANDARD | Standard plugs

P/N	DIMENSIONI Sizes		
	Ø FORO Hole	D	H
05001.55.11	4,8	6,4	5,9
05002.55.11	6,4	8,0	8,0
05003.55.11	8,0	9,5	8,0
05004.55.11	9,5	12,0	10,0
05005.55.11	11,0	13,5	10,3
05006.55.11	12,7	14,6	10,3
05007.55.11	12,7	14,7	14,3
05008.55.11	14,3	16,7	10,3
05009.55.11	15,9	18,2	10,3
05010.55.11	15,9	18,2	11,5
05011.55.11	16,0	18,5	10,3
05012.55.11	17,5	20,0	10,3
05013.55.11	19,0	23,2	10,3
05014.55.11	19,1	23,4	11,5
05015.55.11	20,0	22,6	11,5
05016.55.11	20,6	22,6	10,3
05017.55.11	22,2	25,8	11,5
05018.55.11	22,2	25,8	14,3

P/N	DIMENSIONI Sizes		
	Ø FORO Hole	D	H
05019.55.11	25,0	29,8	11,5
05020.55.11	25,4	30,6	11,5
05021.55.11	25,4	30,6	14,3
05022.55.11	27,8	31,0	11,5
05023.55.11	27,8	30,9	14,3
05024.55.11	30,0	33,3	11,5
05025.55.11	30,1	33,3	11,5
05026.55.11	31,7	34,9	14,3
05027.55.11	32,0	34,9	11,5
05029.55.11	34,9	38,1	10,3
05030.55.11	35,0	38,0	11,5
05031.55.11	38,0	42,7	11,5
05032.55.11	38,1	42,4	14,3
05033.55.11	44,5	48,4	11,5
05034.55.11	45,0	48,4	11,5
05035.55.11	50,8	55,1	14,3
05036.55.11	51,0	55,0	11,5

TAPPI 4 | Hole plugs 4

MATERIALE | MATERIAL: Polietilene | PE LD (Low density polyethylene)

COLORI STANDARD | STANDARD COLOURS: Nero | Black

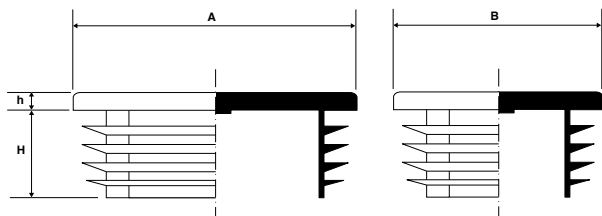

TAPPI TESTA DI TUBO RETTANGOLARI | Rectangular pipe end plugs

P/N	DIMENSIONI Sizes		
	AxB	h	H
02001.55.21	20 x 10	3,0	11,0
02002.55.21	20 x 15	5,0	11,5
02003.55.21	20 x 16	5,0	11,5
02004.55.21	25 x 10	3,0	11,5
02005.55.21	25 x 15	5,0	11,5
02006.55.21	25 x 20	3,0	11,5
02007.55.21	30 x 10	5,0	11,5
02008.55.21	30 x 15	5,0	11,5
02009.55.21	30 x 20	5,0	11,5
02010.55.21	30 x 25	3,5	13,5
02011.55.21	35 x 10	5,0	11,5
02012.55.21	35 x 15	5,0	11,5
02013.55.21	35 x 20	5,0	11,5
02014.55.21	35 x 25	5,0	11,5
02016.55.21	38,1 x 19,1	5,0	11,5
02017.55.21	38,1 x 25,4	5,0	11,5
02018.55.21	40 x 10	5,0	10,5
02019.55.21	40 x 15	5,0	12,0
02020.55.21	40 x 20	5,0	12,0
02021.55.21	40 x 25	5,0	11,5
02022.55.21	40 x 30	5,0	12,0
02023.55.21	40 x 35	5,0	12,0
02024.55.21	45 x 15	5,0	11,0
02025.55.21	45 x 20	5,0	11,5
02026.55.21	45 x 25	5,0	12,0
02027.55.21	45 x 30	5,0	12,0
02028.55.21	45 x 35	5,0	12,0
02029.55.21	50 x 10	3,5	12,0
02030.55.21	50 x 20	5,0	14,0
02031.55.21	50 x 25	5,0	14,5
02032.55.21	50 x 30	5,0	13,5
02033.55.21	50 x 34	5,0	14,5
02034.55.21	50 x 35	5,0	14,5
02035.55.21	50 x 40	5,0	12,5

P/N	DIMENSIONI Sizes		
	AxB	h	H
02036.55.21	50,8 x 38,1	5,0	14,5
02037.55.21	55 x 34	5,0	14,5
02038.55.21	55 x 40	5,0	14,5
02039.55.21	60 x 15	5,0	14,5
02040.55.21	60 x 20	5,0	14,5
02041.55.21	60 x 25	5,0	14,0
02042.55.21	60 x 30	5,0	15,0
02043.55.21	60 x 33	5,0	14,5
02044.55.21	60 x 35	5,0	15,0
02045.55.21	60 x 40	5,0	14,0
02046.55.21	60 x 45	5,0	15,0
02047.55.21	60 x 50	5,0	14,5
02048.55.21	70 x 20	5,0	19,0
02049.55.21	70 x 25	5,0	18,0
02050.55.21	70 x 30	5,0	18,0
02051.55.21	70 x 35	5,0	15,0
02052.55.21	70 x 40	5,0	18,0
02053.55.21	70 x 50	5,0	15,0
02054.55.21	75 x 25	5,0	15,0
02055.55.21	75 x 50	5,0	15,0
02056.55.21	76,2 x 25,4	5,0	14,5
02057.55.21	80 x 20	5,0	18,0
02058.55.21	80 x 25	5,0	14,5
02059.55.21	80 x 30	5,0	14,5
02060.55.21	80 x 40	5,0	14,5
02061.55.21	80 x 50	5,0	18,0
02062.55.21	80 x 60	5,0	24,0
02063.55.21	90 x 20	5,0	14,5
02064.55.21	90 x 40	5,0	15,0
02065.55.21	90 x 45	5,0	15,0
02066.55.21	90 x 50	6,0	22,0
02067.55.21	90 x 70	6,0	22,0
02068.55.21	100 x 20	5,0	15,0
02069.55.21	100 x 25	5,0	15,0
02070.55.21	100 x 30	5,0	15,0

TAPPI 4 | Hole plugs 4

MATERIALE | MATERIAL: Polietilene | PE LD (Low density polyethylene)

COLORI STANDARD | STANDARD COLOURS: Nero | Black

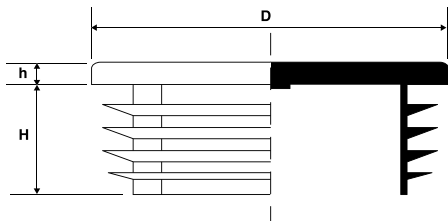

TAPPI TESTA DI TUBO ROTONDI | Round pipe end plugs

P/N	DIMENSIONI Sizes		
	D	h	H
01010.55.21	10,0	3,5	11,0
01012.55.21	12,0	3,5	11,0
01013.55.21	13,0	4,0	11,0
01014.55.21	14,0	5,0	11,5
01015.55.21	15,0	3,0	13,0
01016.55.21	16,0	5,0	11,0
01019.55.21	19,0	5,0	11,5
01020.55.21	20,0	5,0	11,5
01021.55.21	21,0	5,0	11,5
01022.55.21	22,0	5,0	11,5
01023.55.21	23,0	5,0	11,5
01024.55.21	24,0	5,0	11,5
01025.55.21	25,0	5,0	11,5
01026.55.21	26,0	5,0	11,5
01027.55.21	27,0	5,0	11,5
01028.55.21	28,0	5,0	11,5
01030.55.21	30,0	5,0	11,5
01032.55.21	32,0	5,0	12,0
01034.55.21	34,0	5,0	11,5
01035.55.21	35,0	5,0	11,5
01036.55.21	36,0	5,0	11,5
01037.55.21	37,0	5,0	11,5
01038.55.21	38,0	5,0	11,5
01040.55.21	40,0	5,0	11,5
01042.55.21	42,0	5,0	11,5
01043.55.21	43,0	5,0	11,5
01045.55.21	45,0	5,0	11,0
01046.55.21	46,0	5,0	11,5
01048.55.21	48,0	5,0	11,5
01050.55.21	50,0	5,0	11,5
01052.55.21	52,0	5,0	14,5
01055.55.21	55,0	5,0	11,5

P/N	DIMENSIONI Sizes		
	D	h	H
01060.55.21	60,0	5,0	18,5
01065.55.21	65,0	5,0	21,0
01070.55.21	70,0	5,0	21,0
01075.55.21	75,0	6,0	21,5
01076.55.21	76,0	6,0	21,5
01080.55.21	80,0	4,0	21,0
01085.55.21	85,0	6,0	21,0
01088.55.21	88,9	6,0	21,5
01090.55.21	90,0	6,0	20,0
01095.55.21	95,0	6,0	21,0
01100.55.21	100,0	6,0	28,5
01102.55.21	102,0	5,0	20,0
01105.55.21	105,0	6,0	29,0
01108.55.21	108,0	6,0	28,0
01110.55.21	110,0	6,0	28,5
01114.55.21	114,0	6,0	29,0
01120.55.21	120,0	6,0	28,5
01125.55.21	125,0	6,0	33,0
01127.55.21	127,0	6,0	33,0
01130.55.21	130,0	6,0	33,0
01133.55.21	133,0	6,0	33,0
01140.55.21	140,0	6,0	34,0
01150.55.21	150,0	6,0	34,0
01159.55.21	159,0	6,0	34,0
01160.55.21	160,0	6,0	34,0
01165.55.21	165,0	6,0	34,0

MATERIALE | MATERIAL: Polietilene | PE LD (Low density polyethylene)

COLORI STANDARD | STANDARD COLOURS:

Nero - Bianco - Grigio. Altri colori e articoli speciali su richiesta. | Black - White - Grey. Other colours and special items on demand.

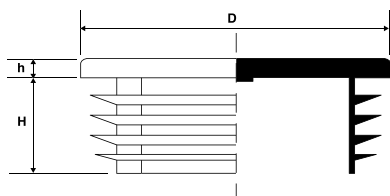

INSERTO LAMELLE QUADRATO | Square hole plugs

P/N	DIMENSIONI Sizes			SPESSORE TUBO Pipe thickness	
	D	h	H	Min.	Max.
10001.55.21	10 x 10	4,0	12,0	1,0	2,0
10002.55.21	12 x 12	4,0	12,0	1,0	2,0
10003.55.21	13 x 13	4,0	12,0	0,5	2,0
10004.55.21	15 x 15	3,0	14,0	1,0	2,0
10005.55.21	16 x 16	5,0	11,5	1,0	2,5
10006.55.21	18 x 18	5,0	11,5	1,5	3,0
10007.55.21	19 x 19	5,0	11,5	1,2	2,9
10008.55.21	20 x 20	5,0	11,5	1,0	3,0
10009.55.21	22 x 22	5,0	12,0	1,0	3,5
10010.55.21	22 x 22	5,0	11,5	3,5	4,0
10011.55.21	22 x 22	5,0	11,5	4,5	5,0
10012.55.21	22 x 22	5,0	11,5	5,0	5,5
10013.55.21	25 x 25	5,0	11,5	1,0	3,0
10014.55.21	25 x 25	5,0	11,5	3,0	3,5
10015.55.21	25 x 25	5,0	11,5	4,0	4,5
10016.55.21	25 x 25	5,0	11,5	5,0	5,5
10017.55.21	25,4 x 25,4	5,0	11,5	1,2	3,2
10018.55.21	28 x 28	5,0	11,5	1,0	3,0
10019.55.21	30 x 30	5,0	11,5	1,0	2,5
10020.55.21	30 x 30	5,0	11,5	2,5	4,5
10021.55.21	32 x 32	5,0	11,5	1,0	3,5
10022.55.21	34 x 34	5,0	14,5	1,0	3,0
10023.55.21	35 x 35	5,0	14,5	1,0	3,0
10024.55.21	35 x 35	5,0	12,0	2,5	5,0
10025.55.21	38 x 38	5,0	14,5	1,0	3,5
10026.55.21	40 x 40	5,0	14,5	1,0	3,0
10027.55.21	40 x 40	5,0	14,5	3,0	5,0
10028.55.21	40 x 40	5,0	14,5	4,0	4,5
10029.55.21	40 x 40	5,0	14,5	4,5	5,5
10030.55.21	45 x 45	5,0	14,5	1,0	3,0
10031.55.21	45 x 45	5,0	14,5	3,0	5,0
10032.55.21	48,3 x 48,3	5,0	14,5	1,0	2,5
10033.55.21	48,3 x 48,3	5,0	14,5	2,5	4,5

P/N	DIMENSIONI Sizes			SPESSORE TUBO Pipe thickness	
	D	h	H	Min.	Max.
10034.55.21	50 x 50	5,0	14,5	1,0	2,5
10035.55.21	50 x 50	6,5	25,0	2,6	4,0
10036.55.21	50 x 50	5,0	14,5	3,5	6,0
10037.55.21	50,8 x 50,8	5,0	14,5	1,2	3,2
10038.55.21	52 x 52	5,0	14,0	1,5	3,5
10039.55.21	55 x 55	5,0	14,5	2,0	4,5
10040.55.21	57,2 x 57,2	4,0	14,5	1,5	3,0
10041.55.21	60 x 60	5,0	24,0	1,5	3,5
10042.55.21	60 x 60	6,5	17,5	3,0	5,0
10043.55.21	63,5 x 63,5	6,0	21,0	1,5	4,0
10044.55.21	65 x 65	5,0	21,0	2,0	4,5
10045.55.21	70 x 70	5,0	19,0	2,0	5,0
10046.55.21	70 x 70	8,0	19,5	3,6	5,0
10047.55.21	75 x 75	6,0	21,0	2,0	4,5
10048.55.21	76,2 x 76,2	6,0	21,0	2,5	5,0
10049.55.21	80 x 80	6,0	21,0	2,0	4,0
10050.55.21	80 x 80	8,0	24,0	3,0	5,0
10051.55.21	80 x 80	6,0	21,0	4,0	6,0
10052.55.21	82,6 x 82,6	6,0	21,0	2,0	4,5
10053.55.21	88,9 x 88,9	6,0	21,0	2,0	4,0
10054.55.21	90 x 90	6,0	25,0	3,0	5,0
10055.55.21	95 x 95	6,0	21,5	3,5	5,5
10056.55.21	100 x 100	7,0	24,0	1,0	4,0
10057.55.21	100 x 100	7,0	24,0	5,0	8,0
10058.55.21	101,6 x 101,6	6,0	24,0	2,5	5,5
10059.55.21	110 x 110	6,0	24,0	3,0	5,0
10060.55.21	114,3 x 114,3	6,0	24,0	2,5	5,5
10061.55.21	120 x 120	5,0	25,0	2,5	5,0
10062.55.21	125 x 125	5,0	25,0	3,0	6,0
10063.55.21	140 x 140	6,0	34,0	4,0	7,0
10064.55.21	150 x 150	6,0	27,0	5,0	8,0
10065.55.21	150 x 150	6,0	27,0	10,0	12,5

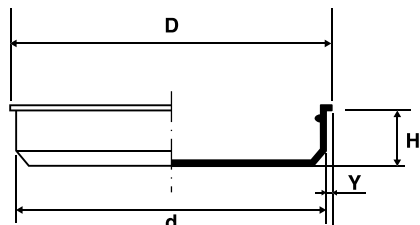
MATERIALE | MATERIAL: Polietilene | PE LD (Low density polyethylene)**COLORI STANDARD** | STANDARD COLOURS: Nero | Black

P/N	DIMENSIONI Sizes			
	d	D	H	Y
06001.55.20	2,0	6,5	3,0	2,25
06002.55.20	2,5	6,5	3,5	2,00
06003.55.20	3,0	6,5	4,5	1,75
06004.55.20	3,5	7,0	4,5	1,75
06005.55.20	4,0	7,5	5,0	1,75
06006.55.20	4,5	8,0	5,0	1,75
06007.55.20	5,0	9,0	6,0	2,00
06008.55.20	5,5	9,0	6,0	1,75
06009.55.20	6,0	9,5	6,0	1,75
06010.55.20	6,5	10,0	7,0	1,75
06011.55.20	7,0	10,0	6,0	1,50
06012.55.20	7,5	10,5	6,5	1,50
06013.55.20	8,0	11,0	7,0	1,50
06014.55.20	8,5	11,5	7,5	1,50
06015.55.20	9,0	11,5	7,5	1,50
06016.55.20	9,5	12,5	7,5	1,50
06017.55.20	10,0	13,0	8,5	1,50
06018.55.20	10,5	13,5	8,5	1,50
06019.55.20	11,0	14,5	8,5	1,75
06020.55.20	11,5	14,5	8,5	1,50
06021.55.20	12,0	14,5	9,0	1,25
06022.55.20	12,5	15,5	9,0	1,50
06023.55.20	13,0	16,5	9,5	1,75
06024.55.20	13,5	16,5	9,5	1,50
06025.55.20	14,0	17,5	10,0	1,75
06026.55.20	14,5	17,5	9,5	1,50
06027.55.20	15,0	18,0	9,5	1,50
06028.55.20	15,5	18,5	9,5	1,50
06029.55.20	16,0	19,5	10,0	1,75
06030.55.20	16,5	19,5	10,5	1,50
06031.55.20	17,0	20,5	10,5	1,75
06032.55.20	17,5	21,0	10,5	1,75
06033.55.20	18,0	21,5	10,5	1,75
06034.55.20	18,5	23,0	10,0	2,25

P/N	DIMENSIONI Sizes			
	d	D	H	Y
06035.55.20	19,0	22,0	10,0	1,50
06036.55.20	19,5	23,0	10,5	1,75
06037.55.20	20,0	23,5	11,0	1,75
06038.55.20	20,5	24,5	10,5	2,00
06039.55.20	21,0	24,5	11,0	1,75
06040.55.20	21,5	25,5	11,0	2,00
06041.55.20	22,0	25,5	11,0	1,75
06042.55.20	22,5	26,0	10,5	1,75
06043.55.20	23,0	27,0	10,5	2,00
06044.55.20	23,5	27,5	10,5	2,00
06045.55.20	24,0	28,0	11,5	2,00
06046.55.20	24,5	28,0	10,5	1,75
06047.55.20	25,0	30,0	11,0	2,50
06048.55.20	25,5	29,0	10,5	1,75
06049.55.20	26,0	30,5	10,5	2,25
06050.55.20	26,5	30,0	10,5	1,75
06051.55.20	27,0	31,0	9,5	2,00
06052.55.20	27,5	31,0	10,5	1,75
06053.55.20	28,0	32,5	10,5	2,25
06054.55.20	28,5	32,0	10,0	1,75
06055.55.20	29,0	32,0	9,5	1,50
06056.55.20	29,5	33,0	10,5	1,75
06057.55.20	30,0	33,0	10,0	1,50
06058.55.20	30,5	34,0	10,0	1,75
06059.55.20	31,0	36,0	10,5	2,50
06060.55.20	31,5	35,0	10,5	1,75
06061.55.20	32,0	37,0	10,5	2,50
06062.55.20	32,5	37,5	10,5	2,50
06063.55.20	33,0	38,0	10,5	2,50
06064.55.20	33,5	37,5	10,5	2,00
06065.55.20	34,0	38,5	10,5	2,25
06066.55.20	34,5	38,0	10,5	1,75
06067.55.20	35,0	40,0	10,5	2,50

MATERIALE | MATERIAL: Polietilene | PE LD (Low density polyethylene)

COLORI STANDARD | STANDARD COLOURS: Nero | Black

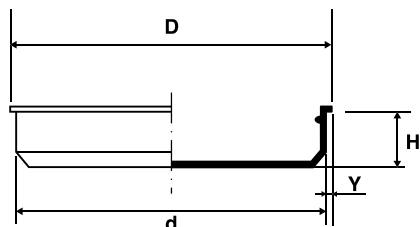

P/N	DIMENSIONI Sizes			
	d	D	H	Y
06068.55.20	35,5	39,0	10,5	1,75
06069.55.20	36,0	41,0	11,0	2,50
06070.55.20	36,5	40,0	10,5	1,75
06071.55.20	37,0	42,0	11,0	2,50
06072.55.20	37,5	41,5	10,5	2,00
06073.55.20	38,0	43,0	10,5	2,50
06074.55.20	38,5	42,0	10,5	1,75
06075.55.20	39,0	44,0	10,5	2,50
06076.55.20	39,5	43,3	10,7	1,90
06077.55.20	40,0	45,0	10,5	2,50
06078.55.20	41,0	46,0	10,5	2,50
06079.55.20	42,0	46,5	10,5	2,25
06080.55.20	43,0	47,8	10,7	2,40
06081.55.20	44,0	49,0	10,5	2,50
06082.55.20	45,0	50,8	10,6	2,90
06083.55.20	46,0	50,8	10,0	2,40
06084.55.20	47,0	51,5	10,5	2,25
06085.55.20	48,0	53,0	10,5	2,50
06086.55.20	48,5	52,0	10,5	1,75
06087.55.20	49,0	54,5	11,0	2,25
06088.55.20	50,0	54,0	10,0	2,00
06089.55.20	51,0	56,0	11,0	2,50
06090.55.20	52,0	57,5	11,0	2,75
06091.55.20	53,0	59,0	11,0	3,00
06092.55.20	53,5	55,5	9,5	1,00
06093.55.20	54,0	61,0	11,0	3,50
06094.55.20	55,0	61,0	10,0	3,00
06095.55.20	56,0	63,0	11,5	3,50
06096.55.20	56,5	59,5	10,5	1,50
06097.55.20	57,0	61,0	10,0	2,00
06098.55.20	58,0	65,0	11,0	3,50
06099.55.20	59,0	65,0	11,0	3,00
06100.55.20	60,0	65,0	11,0	2,50

P/N	DIMENSIONI Sizes			
	d	D	H	Y
06101.55.20	61,0	67,5	11,0	3,25
06102.55.20	62,0	68,0	11,0	3,00
06103.55.20	63,0	67,0	9,5	2,00
06104.55.20	63,5	70,0	10,5	3,25
06105.55.20	64,0	67,5	9,5	1,75
06106.55.20	65,0	69,0	10,0	2,00
06107.55.20	66,0	72,0	10,0	3,00
06108.55.20	67,0	73,0	10,0	3,00
06109.55.20	68,0	75,0	11,0	4,00
06110.55.20	69,0	75,0	10,5	3,00
06111.55.20	70,0	74,0	11,0	2,00
06112.55.20	71,0	74,5	11,0	1,75
06113.55.20	71,5	74,5	10,5	1,50
06114.55.20	72,0	79,0	12,0	3,50
06115.55.20	73,0	76,5	9,5	1,75
06116.55.20	74,0	77,5	10,5	1,75
06117.55.20	75,0	79,0	9,5	2,00
06118.55.20	76,0	80,0	10,5	2,00
06119.55.20	77,0	81,0	9,5	2,00
06120.55.20	78,0	82,0	10,5	2,00
06121.55.20	79,0	83,0	9,6	2,00
06122.55.20	80,0	84,0	9,5	2,00
06123.55.20	81,0	85,0	9,5	2,00
06124.55.20	82,0	85,5	9,5	1,75
06125.55.20	83,0	86,5	9,5	1,75
06126.55.20	84,0	90,0	10,0	2,00
06127.55.20	84,5	90,0	8,0	2,75
06128.55.20	85,0	88,5	9,5	1,75
06129.55.20	86,0	90,0	9,5	2,00
06130.55.20	86,5	89,0	10,0	1,25
06131.55.20	87,0	90,5	9,5	1,75
06132.55.20	88,0	91,5	9,5	1,75

PUNTALI MORBIDI | Soft caps

MATERIALE | MATERIAL: PVC | PVC

COLORI STANDARD | STANDARD COLOURS: Nero | Black

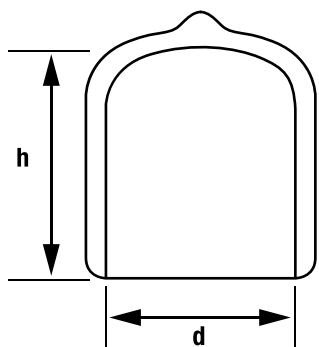

P/N	DIMENSIONI Sizes	
	D	H
08001.55.51	2,0	13,0
08002.55.51	2,8	13,0
08003.55.51	3,2	13,0
08004.55.51	3,6	13,0
08005.55.51	3,6	19,0
08006.55.51	3,6	25,0
08007.55.51	3,9	13,0
08009.55.51	3,9	19,0
08010.55.51	3,9	25,0
08011.55.51	4,4	13,0
08012.55.51	4,4	19,0
08013.55.51	4,4	25,0
08014.55.51	4,8	13,0
08015.55.51	4,8	19,0

P/N	DIMENSIONI Sizes	
	D	H
08016.55.51	4,8	25,0
08017.55.51	5,2	13,0
08018.55.51	5,2	19,0
08019.55.51	5,2	25,0
08020.55.51	5,5	13,0
08021.55.51	5,5	19,0
08022.55.51	5,5	25,0
08023.55.51	5,9	13,0
08024.55.51	5,9	19,0
08025.55.51	5,9	25,0
08026.55.51	6,4	13,0
08027.55.51	6,4	19,0
08028.55.51	6,4	25,0

TAPPI A TESTA PIANA | Flat head caps

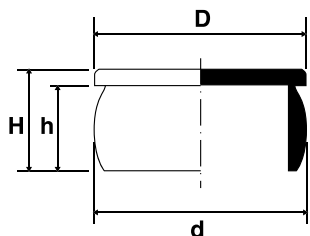
MATERIALE | MATERIAL: Polietilene | PE LD (Low density polyethylene)**COLORI STANDARD** | STANDARD COLOURS: Naturale - Articoli speciali su richiesta | Natural - Special items on demand

P/N	FILETTATURA Thread	DIMENSIONI Sizes			
		d	D	h	H
09001.55.20	-	2,1	3,5	7,0	-
09002.55.20	-	2,6	12,0	4,0	-
09003.55.20	-	2,7	12,0	6,0	-
09004.55.20	-	3,3	12,0	6,0	-
09005.55.20	-	4,4	9,0	5,2	-
09006.55.20	-	4,6	7,0	5,0	-
09007.55.20	-	5,4	12,0	7,5	9,5
09008.55.20	-	6,3	9,6	4,0	1,1
09009.55.20	-	6,6	7,5	5,0	-
09010.55.20	M8 x 1	7,3	14,0	6,0	8,0
09011.55.20	-	8,4	14,0	6,0	8,0
09012.55.20	-	8,8	11,5	8,0	-
09013.55.20	-	9,3	12,0	9,0	-
09014.55.20	M10	9,3	14,0	4,5	6,5
09015.55.20	1/8" GAS	9,3	16,0	6,8	8,3
09016.55.20	-	10,0	12,0	4,0	-
09017.55.20	-	10,0	15,0	9,0	-
09018.55.20	M12 x 1,5	10,7	14,0	5,5	7,5
09019.55.20	-	10,7	14,8	9,0	-
09020.55.20	M12 x 1,25 - M12 x 1	11,3	14,4	5,5	2,0
09021.55.20	M14	11,9	16,0	7,0	9,0
09022.55.20	-	12,3	16,0	7,0	9,0
09023.55.20	M14 x 1,5	12,8	20,0	7,8	10,3

P/N	FILETTATURA Thread	DIMENSIONI Sizes			
		d	D	h	H
09024.55.20	M14 x 1,5 M14 x 1,25	13,7	18,7	7,0	2,0
09025.55.20	-	13,7	20,0	8,0	10,0
09026.55.20	-	14,0	18,7	7,0	2,0
09027.55.20	-	14,5	20,0	5,5	7,5
09028.55.20	-	14,6	18,5	9,5	-
09029.55.20	M16 x 1,5	15,0	18,7	7,0	2,0
09030.55.20	-	15,6	20,0	8,0	10,0
09031.55.20	M18 x 2 - M18 x 1,5 M18 x 1	16,5	18,7	7,0	2,0
09032.55.20	-	17,0	22,0	8,2	10,8
09033.55.20	M20 x 2	17,8	24,6	9,0	2,3
09034.55.20	-	18,4	25,0	8,0	10,5
09035.55.20	-	18,8	21,5	9,0	-
09036.55.20	1/2" GAS	19,3	25,0	8,0	10,5
09037.55.20	M22 x 2	19,5	24,6	9,0	2,1
09038.55.20	-	20,5	25,5	9,0	-
09039.55.20	M22 x 1,5	20,5	30,0	10,7	13,2
09040.55.20	M22 x 1,5	20,1	24,6	9,0	2,1
09041.55.20	-	21,0	26,0	13,0	-
09042.55.20	5/8" GAS	21,2	25,0	7,5	9,5
09043.55.20	-	21,7	25,0	8,0	10,5
09044.55.20	M24 x 2	22,4	28,0	9,0	12,0

TAPPI A TESTA PIANA | Flat head caps

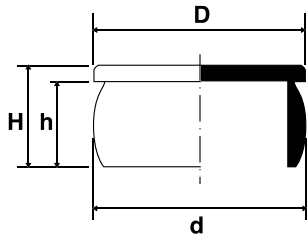
MATERIALE | MATERIAL: Polietilene | PE LD (Low density polyethylene)**COLORI STANDARD** | STANDARD COLOURS: Naturale - Articoli speciali su richiesta | Natural - Special items on demand

P/N	FILETTATURA Thread	DIMENSIONI Sizes			
		d	D	h	H
09045.55.20	-	23,0	27,4	19,3	-
09046.55.20	-	23,4	28,0	3,0	12,0
09047.55.20	-	24,0	27,0	12,8	-
09048.55.20	3/4" GAS	24,6	28,0	9,0	12,0
09049.55.20	-	24,8	31,5	6,0	-
09050.55.20	-	25,0	32,0	13,0	-
09051.55.20	M27 x 1,5	25,5	28,0	7,5	9,5
09052.55.20	M28 x 1,5	26,5	28,0	9,0	12,0
09053.55.20	-	27,0	29,6	15,0	-
09054.55.20	M30 x 3	27,5	34,8	12,0	2,5
09055.55.20	-	28,6	34,0	15,0	-
09056.55.20	-	29,0	36,0	12,0	15,0
09057.55.20	7/8" GAS	30,5	36,0	12,0	15,0
09058.55.20	M33 x 1,5 - 1" GAS	31,8	36,0	10,0	12,5
09059.55.20	M33 x 2 - M33 x 1,5 M36 x 3	32,6	34,8	12,0	2,5
09060.55.20	M35 x 1,5	33,5	36,0	12,0	15,0
09061.55.20	-	33,5	41,0	12,0	-
09062.55.20	-	34,8	42,0	15,0	18,0
09063.55.20	-	35,5	46,5	15,0	-
09064.55.20	-	36,5	45,0	15,0	18,0
09065.55.20	M39 x 3	37,6	40,4	12,0	2,5
09066.55.20	-	38,4	42,0	15,0	18,0

P/N	FILETTATURA Thread	DIMENSIONI Sizes			
		d	D	h	H
09067.55.20	-	40,6	44,0	15,0	18,0
09068.55.20	-	42,0	44,5	16,0	18,0
09069.55.20	-	36,5	47,0	18,0	20,0
09070.55.20	-	42,3	48,0	15,0	18,0
09071.55.20	-	43,3	50,5	15,0	-
09072.55.20	-	46,0	55,0	18,0	21,0
09073.55.20	-	50,5	57,0	14,0	-
09074.55.20	1 3/4" GAS	51,5	55,0	18,0	21,0
09075.55.20	-	52,5	60,0	14,0	-
09076.55.20	M56 x 4 - M56 x 3 M56 x 2	54,1	58,7	18,0	3,0
09077.55.20	-	55,3	59,5	19,5	-
09078.55.20	2" GAS	58,0	64,0	18,0	21,0
09079.55.20	-	59,6	73,5	18,0	3,0
09080.55.20	M72 x 2	70,0	78,0	18,0	21,5
09081.55.20	M75 x 1,5	73,7	82,3	17,4	3,0
09082.55.20	M80 x 4	80,8	92,5	17,4	3,0
09083.55.20	-	85,0	93,5	18,0	-
09084.55.20	M76 x 2	86,5	99,3	17,4	-
09085.55.20	M100 x 2	98,8	112,0	17,4	3,0
09086.55.20	-	110,5	130,0	18,0	-
09087.55.20	M115 x 4	111,7	123,0	17,4	3,0

CAPSULE FILETTATE | Thread caps

MATERIALE | MATERIAL: Polietilene | PE LD (Low density polyethylene)**COLORI STANDARD** | STANDARD COLOURS: Rosso - Articoli speciali su richiesta | Red - Special items on demand

P/N	FILETTATURA Thread	DIMENSIONI Sizes		
		H	D	h

GAS/BSP | GAS/BSP

18001.55.24	1/8" x 28	12,0	11,8	6,5
18002.55.24	1/4" x 19	11,0	14,8	8,0
18003.55.24	3/8" x 19	11,3	18,7	7,4
18004.55.24	1/2" x 14	13,5	23,2	7,0
18005.55.24	5/8" x 14	15,7	25,4	10,0
18006.55.24	3/4" x 14	17,7	29,4	11,2
18007.55.24	7/8" x 14	19,5	32,4	12,5
18008.55.24	1" x 11	19,0	36,0	14,5
18009.55.24	1 1/4" x 11	19,8	44,4	13,0
18010.55.24	1 1/2" x 11	20,5	50,3	14,0
18011.55.24	2" x 11	21,0	61,9	15,0
18012.55.24	2 1/4" x 11	25,0	71,5	17,5
18013.55.24	2 1/2" x 11	27,6	77,9	19,0

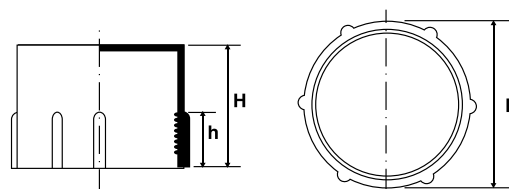
**METRICO** | Metric

18014.55.24	M8 x 1	10,0	9,9	7,0
18015.55.24	M10 x 1	10,0	11,9	7,5
18016.55.24	M12 x 1	12,0	13,8	9,5
18017.55.24	M12 x 1,5	12,0	14,0	9,5
18018.55.24	M14 x 1,5	12,0	15,9	9,5
18019.55.24	M14 x 1,5	20,6	16,0	9,2
18020.55.24	M16 x 1,5	12,0	17,9	9,5
18021.55.24	M16 x 1,5	21,0	18,0	9,0
18022.55.24	M18 x 1,5	14,0	19,7	11,5
18023.55.24	M20 x 1,5	14,0	21,9	9,5
18024.55.24	M22 x 1,5	13,8	24,3	11,5
18025.55.24	M22 x 1,5	24,5	24,4	17,5
18026.55.24	M24 x 1,5	14,0	26,2	11,5
18027.55.24	M25 x 1,5	14,0	27,2	11,5
18028.55.24	M26 x 1,5	14,0	28,3	11,5
18029.55.24	M28 x 1,5	14,0	32,0	12,4
18030.55.24	M30 x 2	14,0	34,0	11,5
18031.55.24	M36 x 2	16,0	38,8	13,5
18032.55.24	M42 x 2	16,0	44,5	13,5
18033.55.24	M52 x 2	16,0	54,7	13,5

P/N	FILETTATURA Thread	DIMENSIONI Sizes		
		H	D	h

UNF/JIC | UNF/JIC

18034.55.24	3/8" x 24	8,3	11,0	4,0
18035.55.24	7/16" x 24	13,7	13,3	7,8
18036.55.24	7/16" x 20	12,9	13,3	8,0
18037.55.24	1/2" x 20	13,5	14,5	9,5
18038.55.24	9/16" x 18	13,5	16,5	9,5
18039.55.24	5/8" x 18	15,6	18,2	7,5
18040.55.24	3/4" x 16	13,8	21,7	9,5
18041.55.24	13/16" x 16	15,3	23,3	9,3
18042.55.24	7/8" x 14	20,2	24,9	14,4
18043.55.24	7/8" x 18	20,0	25,3	14,0
18044.55.24	1" x 14	17,2	27,6	12,0
18045.55.24	1 1/16" x 12	19,0	29,4	11,0
18046.55.24	1 3/16" x 12	19,1	32,7	13,0
18047.55.24	1 5/16" x 12	22,2	36,4	14,5
18048.55.24	1 3/8" x 12	24,5	37,4	10,5
18049.55.24	1 7/16" x 12	21,7	38,9	15,2
18050.55.24	1 5/8" x 12	22,0	44,8	14,0
18051.55.24	1 7/8" x 12	25,0	50,3	15,0

CAPSULE FILETTATE RAPIDE | Quick thread caps

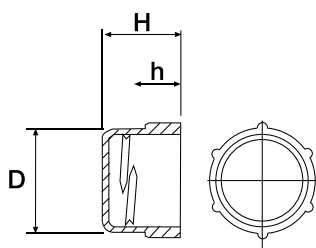
MATERIALE | MATERIAL: Polietilene | PE LD (Low density polyethylene)**COLORI STANDARD** | STANDARD COLOURS: Rosso - Articoli speciali su richiesta | Red - Special items on demand

P/N	MISURA FILETTO Thread	DIMENSIONI Sizes		
		D	H	h
20001.55.24	8 x 1,0	10,0	10,0	6,0
20002.55.24	10 x 1,0	12,0	10,0	6,0
20003.55.24	12 x 1,5	14,0	12,0	7,5
20004.55.24	14 x 1,5	16,0	12,0	7,5
20005.55.24	14 x 1,5	16,0	21,0	8,5
20006.55.24	16 x 1,5	18,0	12,0	7,5
20007.55.24	16 x 1,5	18,0	21,0	6,5
20008.55.24	18 x 1,5	20,0	14,0	9,5
20009.55.24	20 x 1,5	22,0	14,0	9,5
20010.55.24	22 x 1,5	24,5	14,0	9,5
20011.55.24	24 x 1,5	26,5	14,0	9,5
20012.55.24	26 x 1,5	28,5	14,0	9,5
20013.55.24	28 x 1,5	32,0	14,0	9,5
20014.55.24	30 x 2,0	34,0	14,0	9,0

MATERIALE | MATERIAL: Polietilene - Guarnizione in neoprene assemblata | PE HD (High density polyethylene) - Neoprene seal assembled
COLORI STANDARD | STANDARD COLOURS: Giallo - Articoli speciali su richiesta | Yellow - Special items on demand

P/N	MISURA FILETTO Thread	DIMENSIONI Sizes				
		D	H	h	SW1	SW2
UNF UNF						
29001.55.26	1/4" x 28	10,0	13,5	11,5	8,0	8,8
29002.55.26	3/8" x 24	13,0	14,5	12,5	11,0	12,1
29003.55.26	7/16" x 24	15,5	14,5	12,5	13,0	14,3
29004.55.26	7/16" x 20	15,5	15,0	13,0	13,0	14,3
29005.55.26	1/2" x 20	17,5	15,0	13,0	15,0	16,5
29006.55.26	9/16" x 18	18,5	15,5	13,5	16,0	17,5
29007.55.26	5/8" x 18	21,0	15,5	13,5	18,0	19,7
29008.55.26	3/4" x 16	24,0	16,5	14,5	21,0	23,0
29009.55.26	13/16" x 16	26,5	16,5	14,5	23,0	25,2
29010.55.26	7/8" x 18	27,5	15,5	13,5	24,0	26,3
29011.55.26	7/8" x 14	27,5	17,5	15,5	24,0	26,3
29012.55.26	1" x 14	31,0	17,5	15,5	27,0	29,6
29013.55.26	1 1/16" x 12	34,5	18,5	16,5	30,0	32,9
29014.55.26	1 3/16" x 12	36,5	18,5	16,5	32,0	35,1
29015.55.26	1 5/16" x 12	41,0	18,5	16,5	36,0	39,5
29016.55.26	1 3/8" x 12	43,0	18,5	16,5	38,0	41,7
29017.55.26	1 7/16" x 12	45,5	18,5	16,5	40,0	43,9
29018.55.26	1 5/8" x 12	51,0	19,0	16,5	45,0	49,4
29019.55.26	1 3/4" x 16	54,5	17,0	14,5	48,0	52,6
29020.55.26	1 7/8" x 12	59,0	19,0	16,5	52,0	57,0

METRICO Metric						
P/N	MISURA FILETTO Thread	D	H	h	SW1	SW2
29021.55.26	M8 x 1	12,0	13,0	11,0	10,0	11,0
29022.55.26	10 x 1	14,2	13,0	11,0	12,0	13,2
29023.55.26	M12 x 1	16,5	13,0	11,0	14,0	15,4
29024.55.26	M12 x 1,5	16,5	15,0	13,0	14,0	15,4
29025.55.26	M14 x 1,5	18,5	15,0	13,0	16,0	17,5
29026.55.26	M16 x 1,5	21,0	15,0	13,0	18,0	19,7
29027.55.26	M18 x 1,5	23,0	15,0	13,0	20,0	21,9
29028.55.26	M20 x 1,5	25,0	15,0	13,0	22,0	24,1
29029.55.26	M22 x 1,5	27,5	15,0	13,0	24,0	26,3
29030.55.26	M24 x 1,5	30,0	15,0	13,0	26,0	28,5
29031.55.26	M25 x 1,5	31,0	15,0	13,0	27,0	29,6
29032.55.26	M26 x 1,5	32,0	15,0	13,0	28,0	30,7
29033.55.26	M28 x 1,5	34,0	15,0	13,0	30,0	32,9
29034.55.26	M30 x 1,5	36,5	15,0	13,0	32,0	35,1
29035.55.26	M30 x 2	36,5	17,0	15,0	32,0	35,1
29036.55.26	M36 x 1,5	44,5	16,0	14,0	39,0	42,8
29037.55.26	M36 x 2	44,5	18,0	16,0	39,0	42,8
29038.55.26	M42 x 2	51,0	18,5	16,0	45,0	49,4
29039.55.26	M45 x 1,5	54,5	16,5	14,0	48,0	52,6
29040.55.26	M45 x 2	54,5	18,5	16,0	48,0	52,6
29041.55.26	M52 x 2	62,0	18,5	16,0	55,0	60,3

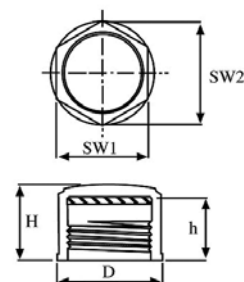

P/N	MISURA FILETTO Thread	DIMENSIONI Sizes				
		D	H	h	SW1	SW2
GAS/BSP GAS/BSP						
29042.55.26	1/8" x 28	14,0	13,0	11,0	12,0	13,2
29043.55.26	1/4" x 19	17,5	15,0	13,0	15,0	16,5
29044.55.26	3/8" x 19	22,0	15,0	13,0	19,0	20,8
29045.55.26	1/2" x 14	27,5	17,0	15,0	24,0	26,0
29046.55.26	5/8" x 14	29,0	17,0	15,0	25,0	27,4
29047.55.26	3/4 x 14	32,0	17,0	15,0	28,0	30,7
29048.55.26	7/8" x 14	36,0	17,0	15,0	32,0	35,1
29049.55.26	1" x 11	41,0	19,0	17,0	36,0	39,5
29050.55.26	1 1/4" x 11	51,0	19,0	17,0	45,0	49,4
29051.55.26	1 1/2" x 11	56,0	19,5	17,0	50,0	54,8
29052.55.26	2" x 11	71,0	19,5	17,0	63,0	69,1
29053.55.26	2 1/4" x 11	80,0	19,5	17,0	70,0	76,8
29054.55.26	2 1/2" x 11	90,0	19,5	17,0	80,0	87,7

MATERIALE | MATERIAL: Nylon 6 | PA 6

COLORI STANDARD | STANDARD COLOURS: Giallo - Articoli speciali su richiesta | Yellow - Special items on demand

P/N	DIMENSIONI Sizes					
	d1	D	H	h	SW1	SW2

METRICO | Metric

30001.55.16	M8 x 1	12,5	15,5	8,0	7,0	4,0
30002.55.16	M10 x 1	14,5	16,5	9,0	9,0	6,0
30003.55.16	M12 x 1,5	17,0	16,5	9,0	10,0	7,0
30004.55.16	M14 x 1,5	19,0	17,5	10,0	13,0	10,0
30005.55.16	M16 x 1,5	22,0	17,5	10,0	15,0	12,0
30006.55.16	M18 x 1,5	24,0	17,5	10,0	17,0	14,0
30007.55.16	M20 x 1,5	26,0	17,5	10,0	19,0	16,0
30008.55.16	M22 x 1,5	28,0	17,5	10,0	21,0	18,0
30009.55.16	M24 x 1,5	30,0	17,5	10,0	24,0	21,0
30010.55.16	M26 x 1,5	32,0	20,5	12,0	24,0	21,0
30011.55.16	M27 x 1,5	33,0	20,5	12,0	24,0	21,0
30012.55.16	M28 x 1,5	34,0	20,5	12,0	24,0	21,0
30013.55.16	M30 x 1,5	38,0	20,5	12,0	24,0	21,0
30014.55.16	M32 x 1,5	40,0	20,5	12,0	24,0	21,0
30015.55.16	M36 x 1,5	45,0	20,5	12,0	24,0	21,0
30016.55.16	M38 x 1,5	48,0	20,5	12,0	24,0	21,0
30017.55.16	M45 x 1,5	52,0	21,5	12,0	30,0	27,0
30018.55.16	M52 x 1,5	60,0	22,0	12,0	30,0	27,0
30019.55.16	M27 x 2	33,0	22,0	13,5	24,0	21,0
30020.55.16	M30 x 2	38,0	22,0	13,5	24,0	21,0
30021.55.16	M33 x 2	40,0	22,0	13,5	24,0	21,0
30022.55.16	M36 x 2	45,0	22,0	13,5	24,0	21,0
30023.55.16	M42 x 2	50,0	22,0	13,5	30,0	27,0
30024.55.16	M45 x 2	52,0	22,0	13,5	30,0	27,0
30025.55.16	M48 x 2	55,0	23,0	13,5	30,0	27,0
30026.55.16	M52 x 2	60,0	23,0	13,5	30,0	27,0

UNF | UNF

30027.55.16	3/8" x 24	16,0	17,5	10,0	9,0	6,0
30028.55.16	7/16" x 20	17,0	17,5	10,0	10,0	7,0
30029.55.16	3/8" x 24	19,0	17,5	10,0	13,0	10,0
30030.55.16	9/16" x 18	20,5	17,5	10,0	13,0	10,0
30031.55.16	5/8" x 18	22,0	17,5	10,0	15,0	12,0
30032.55.16	3/4" x 16	26,0	17,5	10,0	19,0	16,0
30033.55.16	7/8" x 14	28,5	19,5	12,0	21,0	18,0
30034.55.16	1" x 14	31,5	19,5	12,0	24,0	21,0
30035.55.16	1 1/16" x 12	33,0	19,5	12,0	24,0	21,0
30036.55.16	1 3/16" x 12	36,5	22,5	15,0	30,0	27,0
30037.55.16	1 5/16" x 12	40,0	22,5	15,0	30,0	27,0
30038.55.16	1 5/8" x 12	47,5	22,5	15,0	36,0	33,0
30039.55.16	1 7/8" x 12	54,0	22,5	15,0	36,0	33,0

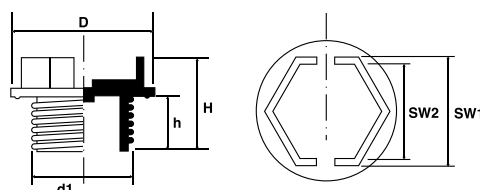

P/N	DIMENSIONI Sizes					
	d1	D	H	h	SW1	SW2

GAS | GAS

30040.55.16	1/8" x 28	16,0	15,5	8,0	12,0	9,0
30041.55.16	1/4" x 19	19,0	17,5	10,0	13,0	10,0
30042.55.16	3/8" x 19	22,0	17,5	10,0	15,0	12,0
30043.55.16	1/2" x 14	27,0	19,5	12,0	19,0	16,0
30044.55.16	5/8" x 14	29,5	19,5	12,0	22,0	19,0
30045.55.16	3/4" x 14	32,0	19,5	12,0	24,0	21,0
30046.55.16	7/8" x 14	37,0	19,5	12,0	27,0	24,0
30047.55.16	1" x 11	40,0	22,5	15,0	30,0	27,0
30048.55.16	1 1/4" x 11	50,0	22,5	15,0	36,0	33,0
30049.55.16	1 1/2" x 11	56,0	24,0	15,0	41,0	37,0
30050.55.16	1 3/4" x 11	62,0	24,0	15,0	50,0	46,0
30051.55.16	2" x 11	68,0	24,0	15,0	55,0	51,0

TAPPI FILETTATI A TENUTA CON O-RING

Watertight thread hole plugs with o-ring

MATERIALE | MATERIAL: Polietilene | PE HD (High density polyethylene)

COLORI STANDARD | STANDARD COLOURS: Giallo - Articoli speciali su richiesta | Yellow - Special items on demand

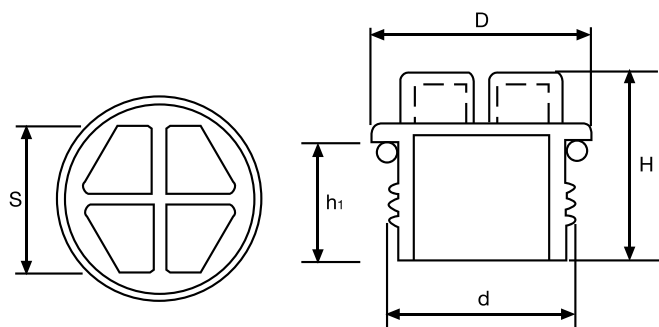

P/N	FILETTATURE Thread	DIMENSIONI Sizes			
		D	H	h1	S

GAS/BSP | GAS/BSP

34001.55.26	1/8" x 28	16,0	17,2	10,0	7,0
34002.55.26	1/4" x 19	19,0	19,7	12,5	10,0
34003.55.26	3/8" x 19	22,0	20,9	12,5	13,0
34004.55.26	1/2" x 14	27,0	21,9	13,5	15,0
34005.55.26	5/8" x 14	29,5	21,9	13,5	17,0
34006.55.26	3/4" x 14	32,0	21,9	13,5	19,0
34007.55.26	7/8" x 14	37,0	21,9	13,5	22,0
34008.55.26	1" x 11	40,0	23,6	15,0	24,0
34009.55.26	1 1/4" x 11	50,0	23,6	15,0	24,0
34010.55.26	1 1/2" x 11	56,0	25,0	15,0	30,0
34011.55.26	1 3/4" x 11	62,0	25,0	15,0	36,0
34012.55.26	2" x 11	68,0	25,0	15,0	36,0

UNF | UNF

34013.55.26	3/8" x 24	14,0	17,2	10,0	7,0
34014.55.26	1/16" x 20	16,0	19,7	12,5	10,0
34015.55.26	1/2" x 20	19,0	20,9	12,5	10,0
34016.55.26	9/16" x 18	21,0	20,9	12,5	10,0
34017.55.26	5/8" x 18	22,0	20,9	12,5	13,0
34018.55.26	3/4" x 16	27,0	21,9	13,5	13,0
34019.55.26	7/8" x 14	28,0	21,9	13,5	15,0
34020.55.26	1" x 14	31,0	22,1	13,5	17,0
34021.55.26	1 1/16" x 12	35,0	22,6	14,0	19,0
34022.55.26	1 3/16" x 12	38,0	22,6	14,0	22,0
34023.55.26	1 5/16" x 12	42,0	24,0	14,0	24,0
34024.55.26	1 5/8" x 12	50,0	24,0	14,0	24,0
34025.55.26	1 7/8" x 12	55,0	24,0	14,0	30,0

P/N	FILETTATURE Thread	DIMENSIONI Sizes			
		D	H	h1	S

GAS/BSP | GAS/BSP

34026.55.26	M8 x 1	12,5	17,0	10,0	6,0
34027.55.26	M10 x 1	14,5	17,2	10,0	7,0
34028.55.26	M12 x 1	17,0	17,2	10,0	10,0
34029.55.26	M10 x 1,5	14,5	19,2	12,0	7,0
34030.55.26	M12 x 1,5	17,0	19,2	12,0	10,0
34031.55.26	M14 x 1,5	22,0	19,2	12,0	10,0
34032.55.26	M16 x 1,5	24,0	20,4	12,0	13,0
34033.55.26	M18 x 1,5	24,0	20,4	12,0	13,0
34034.55.26	M20 x 1,5	26,0	20,4	12,0	15,0
34035.55.26	M22 x 1,5	28,0	20,4	12,0	15,0
34036.55.26	M24 x 1,5	30,0	20,4	12,0	17,0
34037.55.26	M26 x 1,5	32,0	20,4	12,0	19,0
34038.55.26	M28 x 1,5	34,0	20,4	12,0	19,0
34039.55.26	M30 x 1,5	38,0	20,6	12,0	22,0
34040.55.26	M32 x 1,5	40,0	20,6	12,0	24,0
34041.55.26	M36 x 1,5	45,0	20,6	12,0	24,0
34042.55.26	M38 x 1,5	48,0	20,6	12,0	24,0
34043.55.26	M45 x 1,5	52,0	22,0	12,0	24,0
34044.55.26	M52 x 1,5	60,0	22,0	12,0	30,0
34045.55.26	M27 x 2	33,0	24,6	15,0	19,0
34046.55.26	M30 x 2	38,0	24,6	15,0	22,0
34047.55.26	M33 x 2	40,0	24,6	15,0	24,0
34048.55.26	M36 x 2	45,0	24,6	15,0	24,0
34049.55.26	M42 x 2	50,0	24,6	15,0	24,0
34050.55.26	M45 x 2	52,0	25,0	15,0	30,0
34051.55.26	M48 x 2	55,0	25,0	15,0	30,0
34052.55.26	M52 x 2	60,0	25,0	15,0	7,0

TAPPI PROTEZIONE DADI E BULLONI

Nuts and bolts protection caps

MATERIALE | MATERIAL: Polietilene | PE LD (Low density polyethylene)

COLORI STANDARD | STANDARD COLOURS: Nero - Articoli speciali su richiesta | Black - Special items on demand

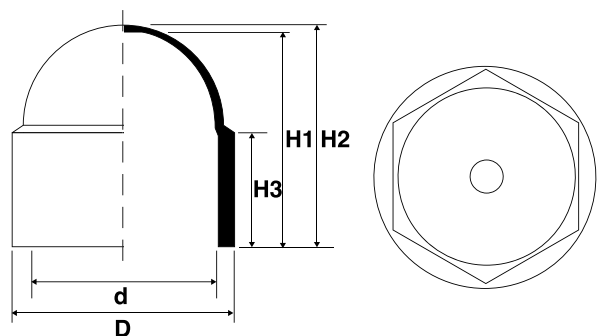

P/N	DIMENSIONI Sizes					ESAGONO Hexagon	FILETTATURE METRICHE Metric threads		
	d	D	H1	H2	H3				
24001.55.21	6,9	9,0	7,5	8,3	3,5	7,0	M4	-	-
24002.55.21	7,9	10,9	8,5	9,5	5,0	8,0	M5	-	-
24003.55.21	9,8	12,9	12,0	13,0	6,0	10,0	M6	-	-
24004.55.21	10,8	14,1	12,0	13,0	6,5	11,0	M7	-	-
24005.55.21	12,8	16,8	14,0	15,0	9,0	13,0	M8	-	M8 x 1
24006.55.21	16,7	21,3	18,5	19,5	9,0	17,0	M10	-	M10 x 1
24007.55.21	18,7	23,6	20,0	21,5	11,0	19,0	M12	-	M12 x 1,5
24008.55.21	21,7	27,5	22,5	24,0	12,0	22,0	M14	-	M14 x 1,5
24009.55.21	23,7	29,8	25,5	27,0	14,0	24,0	M16	-	M16 x 1,5
24010.55.21	26,8	34,0	29,0	43,0	15,0	27,0	M18	M18 x 2	M18 x 1,5
24011.55.21	29,8	37,7	31,0	33,2	17,0	30,0	M20	M20 x 2	M20 x 1,5
24012.55.21	31,8	39,7	34,0	36,2	19,0	32,0	M22	M22 x 2	M22 x 1,5
24013.55.21	35,8	44,4	38,0	39,2	20,0	36,0	M24	M24 x 2	M26 x 1,5 - M24 x 1,5
24014.55.21	40,8	50,1	44,0	46,5	23,0	41,0	M27	M27 x 2	M28 x 1,5 - M27 x 1,5
24015.55.21	45,8	55,9	49,0	51,5	25,0	46,0	M30	M30 x 2	M30 x 1,5
24016.55.21	49,8	60,5	53,0	55,5	27,0	50,0	M33	M33 x 2	M33 x 1,5
24017.55.21	54,8	67,0	57,0	59,5	30,0	55,0	M36	M36 x 2	M36 x 1,5 - M36 x 3
24018.55.21	59,7	72,0	60,0	62,5	38,0	60,0	M39	M39 x 3	M40 x 1,5 - M39 x 1,5
24019.55.21	63,7	76,5	63,0	65,5	42,0	65,0	M42	M42 x 3	M42 x 1,5
24020.55.21	69,7	85,5	73,0	75,5	38,0	70,0	M45	-	-
24021.55.21	75,0	91,6	78,5	81,0	41,0	75,0	M48	-	-
24022.55.21	80,0	98,0	83,4	86,2	43,5	80,0	M52	-	-
24023.55.21	85,0	104,2	88,6	91,6	48,0	85,0	M56	-	-
24024.55.21	95,0	116,7	102,0	105,5	55,0	95,0	M64	-	-

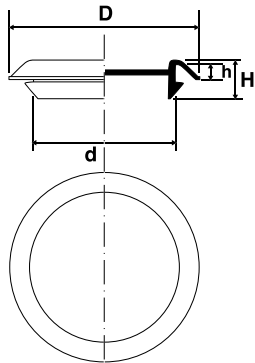
MATERIALE | MATERIAL: Polietilene | PE LD (Low density polyethylene)**COLORI STANDARD** | STANDARD COLOURS: Naturale | Natural

P/N	DIMENSIONI Sizes			
	D	d	h	H
41001.55.20	20,0	9,5	3,0	8,5
41002.55.20	24,0	12,5	3,0	9,8
41003.55.20	27,0	14,0	3,0	10,0
41004.55.20	27,5	16,0	3,0	9,8
41005.55.20	30,5	19,0	3,0	9,8
41006.55.20	31,5	20,0	3,0	9,8
41007.55.20	33,5	22,0	3,0	9,8
41008.55.20	36,0	25,0	1,5	9,0
41009.55.20	36,5	25,0	3,0	9,8
41010.55.20	39,5	28,0	3,0	9,8
41011.55.20	41,0	31,5	3,0	9,2
41012.55.20	49,5	38,0	3,0	9,8
41013.55.20	59,0	47,5	3,0	9,8
41014.55.20	61,5	50,0	3,0	9,8
41015.55.20	62,5	51,0	3,0	9,5

TAPPI IN PVC PER FORI SU LAMIERE

PVC hole metal plates caps

MATERIALE | MATERIAL: PVC | PVC

COLORI STANDARD | STANDARD COLOURS: Nero | Black

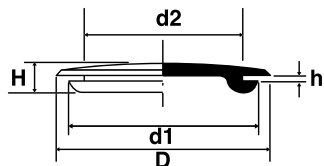

P/N	DIMENSIONI Sizes				
	D	d1	d2	h	H
36001.55.51	9,3	9,3	4,7	1,6	4,6
36002.55.51	9,5	9,5	6,4	1,6	5,0
36003.55.51	14,5	10,6	8,0	0,8	4,0
36004.55.51	14,5	10,6	8,0	1,6	4,5
36005.55.51	15,0	12,4	9,0	1,6	6,6
36006.55.51	17,7	12,8	11,2	1,6	6,2
36007.55.51	17,0	15,5	11,5	1,6	7,0
36008.55.51	17,5	15,9	11,9	1,2	7,1
36009.55.51	19,0	13,1	12,0	0,8	6,5
36010.55.51	18,7	15,5	12,7	1,6	5,6
36011.55.51	20,0	18,4	14,9	1,3	7,0
36012.55.51	22,0	19,0	15,5	1,6	7,5
36013.55.51	19,0	19,0	15,9	1,6	7,1
36014.55.51	20,0	18,5	16,3	1,3	7,0

P/N	DIMENSIONI Sizes				
	D	d1	d2	h	H
36015.55.51	25,0	21,5	19,0	1,6	6,5
36016.55.51	25,0	21,5	20,0	1,6	6,5
36017.55.51	28,5	26,6	22,0	2,4	8,2
36018.55.51	28,5	27,0	22,5	1,6	7,5
36019.55.51	30,0	27,5	24,5	2,4	8,7
36020.55.51	32,0	28,3	25,4	1,6	9,0
36021.55.51	32,0	28,3	25,4	2,4	9,0
36022.55.51	38,5	28,5	25,0	0,8	4,6
36023.55.51	38,2	35,4	32,0	3,1	9,0
36024.55.51	38,2	31,5	31,5	0,8	7,0
36025.55.51	38,2	35,4	31,5	1,6	7,5
36026.55.51	43,7	43,0	38,2	1,6	8,2
36027.55.51	57,5	52,6	51,5	1,6	11,4

MATERIALE | MATERIAL: Nylon 66 | PA 66

COLORI STANDARD | STANDARD COLOURS:

Grigio - Nero - Bianco - Blu - Rosso | Grey - Black - White - Blue - Red

PROTEZIONE | PROTECTION: IP68

INFIAMMABILITÀ | FLAMMABILITY: UL94 V0

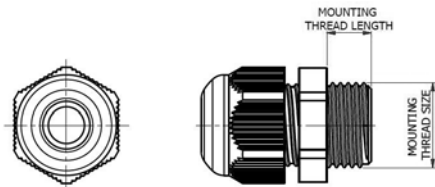

FILETTO PG | PG thread

P/N	FILETTO Thread	DIMENSIONI Sizes	
		LUNGH. FILETTO Thread Length	Ø Cavo Cable Min - Max
37001.55.11	PG7	8,0	3,0 - 6,5
37002.55.17	PG7	8,0	3,0 - 6,5
37003.55.11	PG7	8,0	2,0 - 5,0
37004.55.17	PG7	8,0	2,0 - 5,0
37005.55.11	PG7	15,0	3,0 - 6,5
37006.55.17	PG7	15,0	3,0 - 6,5
37007.55.11	PG7	15,0	2,0 - 5,0
37008.55.17	PG7	15,0	2,0 - 5,0
37009.55.11	PG9	8,0	4,0 - 8,0
37010.55.17	PG9	8,0	4,0 - 8,0
37011.55.11	PG9	8,0	2,0 - 6,0
37012.55.17	PG9	8,0	2,0 - 6,0
37013.55.11	PG9	15,0	4,0 - 8,0
37014.55.17	PG9	15,0	4,0 - 8,0
37015.55.11	PG9	15,0	2,0 - 6,0
37016.55.17	PG9	15,0	2,0 - 6,0
37017.55.11	PG11	8,0	5,0 - 10,0
37018.55.17	PG11	8,0	5,0 - 10,0
37019.55.11	PG11	8,0	3,0 - 7,0
37020.55.17	PG11	8,0	3,0 - 7,0
37021.55.11	PG11	15,0	5,0 - 10,0
37022.55.17	PG11	15,0	5,0 - 10,0
37023.55.11	PG11	15,0	3,0 - 7,0
37024.55.17	PG11	15,0	3,0 - 7,0
37025.55.11	PG13,5	9,0	6,0 - 12,0
37026.55.17	PG13,5	9,0	6,0 - 12,0
37027.55.11	PG13,5	9,0	5,0 - 9,0
37028.55.17	PG13,5	9,0	5,0 - 9,0
37029.55.11	PG13,5	15,0	6,0 - 12,0
37030.55.17	PG13,5	15,0	6,0 - 12,0
37031.55.11	PG13,5	15,0	5,0 - 9,0
37032.55.17	PG13,5	15,0	5,0 - 9,0
37033.55.11	PG16	10,0	10,0 - 14,0
37034.55.17	PG16	10,0	10,0 - 14,0
37035.55.11	PG16	10,0	7,0 - 12,0
37036.55.17	PG16	10,0	7,0 - 12,0
37037.55.11	PG21	10,0	13,0 - 18,0
37038.55.17	PG21	10,0	13,0 - 18,0

P/N	FILETTO Thread	DIMENSIONI Sizes	
		LUNGH. FILETTO Thread Length	Ø Cavo Cable Min - Max
37039.55.11	PG21	10,0	9,0 - 16,0
37040.55.17	PG21	10,0	9,0 - 16,0
37041.55.11	PG21	15,0	13,0 - 18,0
37042.55.17	PG21	15,0	13,0 - 18,0
37043.55.11	PG21	15,0	9,0 - 16,0
37044.55.17	PG21	15,0	9,0 - 16,0
37045.55.11	PG29	12,0	18,0 - 25,0
37046.55.17	PG29	12,0	18,0 - 25,0
37047.55.11	PG29	12,0	13,0 - 20,0
37048.55.17	PG29	12,0	13,0 - 20,0
37049.55.11	PG29	18,0	18,0 - 25,0
37050.55.17	PG29	18,0	18,0 - 25,0
37051.55.11	PG29	18,0	13,0 - 20,0
37052.55.17	PG29	18,0	13,0 - 20,0
37053.55.11	PG36	14,0	22,0 - 32,0
37054.55.17	PG36	14,0	22,0 - 32,0
37055.55.11	PG36	14,0	20,0 - 26,0
37056.55.17	PG36	14,0	20,0 - 26,0
37057.55.11	PG36	18,0	22,0 - 32,0
37058.55.17	PG36	18,0	22,0 - 32,0
37059.55.11	PG36	18,0	20,0 - 26,0
37060.55.17	PG36	18,0	20,0 - 26,0
37061.55.11	PG42	14,0	30,0 - 38,0
37062.55.17	PG42	14,0	30,0 - 38,0
37063.55.11	PG42	14,0	25,0 - 31,0
37064.55.17	PG42	14,0	25,0 - 31,0
37065.55.11	PG42	18,0	32,0 - 38,0
37066.55.17	PG42	18,0	32,0 - 38,0
37067.55.11	PG42	18,0	25,0 - 31,0
37068.55.17	PG42	18,0	25,0 - 31,0
37069.55.11	PG48	14,0	34,0 - 44,0
37070.55.17	PG48	14,0	34,0 - 44,0
37071.55.11	PG48	14,0	29,0 - 35,0
37072.55.17	PG48	14,0	29,0 - 35,0
37073.55.11	PG48	18,0	37,0 - 44,0
37074.55.17	PG48	18,0	37,0 - 44,0
37075.55.11	PG48	18,0	29,0 - 35,0
37076.55.17	PG48	18,0	29,0 - 35,0

MATERIALE | MATERIAL: Nylon 66 | PA 66**COLORI STANDARD** | STANDARD COLOURS:

Grigio - Nero - Bianco - Blu - Rosso | Grey - Black - White - Blue - Red

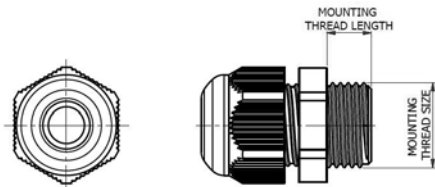
PROTEZIONE | PROTECTION: IP68**INFIAMMABILITÀ** | FLAMMABILITY: UL94 V0**FILETTO METRICO** | Metric thread

P/N	FILETTO Thread	DIMENSIONI Sizes	
		LUNGH. FILETTO Thread Length	Ø Cavo Cable Min - Max
38001.55.11	M12 x 1,5	8,0	3,0 - 6,5
38002.55.17	M12 x 1,5	8,0	3,0 - 6,5
38003.55.11	M12 x 1,5	8,0	2,0 - 5,0
38004.55.17	M12 x 1,5	8,0	2,0 - 5,0
38005.55.11	M12 x 1,5	15,0	3,0 - 6,5
38006.55.17	M12 x 1,5	15,0	3,0 - 6,5
38007.55.11	M12 x 1,5	15,0	2,0 - 5,0
38008.55.17	M12 x 1,5	15,0	2,0 - 5,0
38009.55.11	M16 x 1,5	8,0	4,0 - 8,0
38010.55.17	M16 x 1,5	8,0	4,0 - 8,0
38011.55.11	M16 x 1,5	8,0	2,0 - 6,0
38012.55.17	M16 x 1,5	8,0	2,0 - 6,0
38013.55.11	M16 x 1,5	15,0	4,0 - 8,0
38014.55.17	M16 x 1,5	15,0	4,0 - 8,0
38015.55.11	M16 x 1,5	15,0	2,0 - 6,0
38016.55.17	M16 x 1,5	15,0	2,0 - 6,0
38017.55.11	M20 x 1,5	9,0	6,0 - 12,0
38018.55.17	M20 x 1,5	9,0	6,0 - 12,0
38019.55.12	M20 x 1,5	9,0	6,0 - 12,0
38020.55.13	M20 x 1,5	9,0	6,0 - 12,0
38021.55.14	M20 x 1,5	9,0	6,0 - 12,0
38022.55.11	M20 x 1,5	9,0	5,0 - 9,0
38023.55.17	M20 x 1,5	9,0	5,0 - 9,0
38024.55.12	M20 x 1,5	9,0	5,0 - 9,0
38025.55.13	M20 x 1,5	9,0	5,0 - 9,0
38026.55.14	M20 x 1,5	9,0	5,0 - 9,0
38027.55.11	M20 x 1,5	15,0	6,0 - 12,0
38028.55.17	M20 x 1,5	15,0	6,0 - 12,0
38029.55.11	M20 x 1,5	15,0	5,0 - 9,0
38030.55.17	M20 x 1,5	15,0	5,0 - 9,0
38031.55.11	M25 x 1,5	10,0	13,0 - 18,0
38032.55.17	M25 x 1,5	10,0	13,0 - 18,0
38033.55.11	M25 x 1,5	10,0	9,0 - 16,0
38034.55.17	M25 x 1,5	10,0	9,0 - 16,0
38035.55.11	M25 x 1,5	15,0	13,0 - 18,0
38036.55.17	M25 x 1,5	15,0	13,0 - 18,0
38037.55.12	M25 x 1,5	10,0	13,0 - 18,0
38038.55.13	M25 x 1,5	10,0	13,0 - 18,0

P/N	FILETTO Thread	DIMENSIONI Sizes	
		LUNGH. FILETTO Thread Length	Ø Cavo Cable Min - Max
38039.55.14	M25 x 1,5	10,0	13,0 - 18,0
38040.55.11	M25 x 1,5	15,0	9,0 - 16,0
38041.55.17	M25 x 1,5	15,0	9,0 - 16,0
38042.55.12	M25 x 1,5	10,0	9,0 - 16,0
38043.55.13	M25 x 1,5	10,0	9,0 - 16,0
38044.55.14	M25 x 1,5	10,0	9,0 - 16,0
38045.55.11	M32 x 1,5	11,0	16,0 - 21,0
38046.55.17	M32 x 1,5	11,0	16,0 - 21,0
38047.55.11	M32 x 1,5	11,0	13,0 - 18,0
38048.55.17	M32 x 1,5	11,0	13,0 - 18,0
38049.55.11	M32 x 1,5	15,0	18,0 - 25,0
38050.55.17	M32 x 1,5	15,0	18,0 - 25,0
38051.55.11	M32 x 1,5	15,0	13,0 - 20,0
38052.55.17	M32 x 1,5	15,0	13,0 - 20,0
38053.55.11	M40 x 1,5	14,0	22,0 - 32,0
38054.55.17	M40 x 1,5	14,0	22,0 - 32,0
38055.55.11	M40 x 1,5	14,0	20,0 - 26,0
38056.55.17	M40 x 1,5	14,0	20,0 - 26,0
38057.55.11	M40 x 1,5	18,0	22,0 - 32,0
38058.55.17	M40 x 1,5	18,0	22,0 - 32,0
38059.55.11	M40 x 1,5	18,0	20,0 - 26,0
38060.55.17	M40 x 1,5	18,0	20,0 - 26,0
38061.55.11	M50 x 1,5	14,0	32,0 - 38,0
38062.55.17	M50 x 1,5	14,0	32,0 - 38,0
38063.55.11	M50 x 1,5	14,0	25,0 - 31,0
38064.55.17	M50 x 1,5	14,0	25,0 - 31,0
38065.55.11	M50 x 1,5	18,0	32,0 - 38,0
38066.55.17	M50 x 1,5	18,0	32,0 - 38,0
38067.55.11	M50 x 1,5	18,0	25,0 - 31,0
38068.55.17	M50 x 1,5	18,0	25,0 - 31,0
38069.55.11	M63 x 1,5	14,0	37,0 - 44,0
38070.55.17	M63 x 1,5	14,0	37,0 - 44,0
38071.55.11	M63 x 1,5	14,0	29,0 - 35,0
38072.55.17	M63 x 1,5	14,0	29,0 - 35,0
38073.55.11	M63 x 1,5	18,0	37,0 - 44,0
38074.55.17	M63 x 1,5	18,0	37,0 - 44,0
38075.55.11	M63 x 1,5	18,0	29,0 - 35,0
38076.55.17	M63 x 1,5	18,0	29,0 - 35,0

MATERIALE | MATERIAL: Nylon 66 | PA 66**COLORI STANDARD** | STANDARD COLOURS:

Grigio - Nero - Bianco - Blu - Rosso | Grey - Black - White - Blue - Red

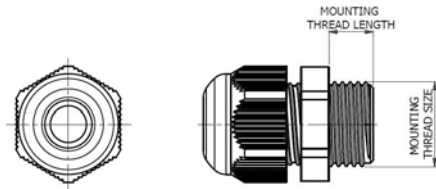
PROTEZIONE | PROTECTION: IP68**INFIAMMABILITÀ** | FLAMMABILITY: UL94 V0**FILETTO NPT** | NPT thread

P/N	FILETTO Thread	DIMENSIONI Sizes	
		LUNGH. FILETTO Thread Length	Ø Cavo Cable Min - Max
39001.55.11	3/8"	15,0	4,0 - 8,0
39002.55.17	3/8"	15,0	4,0 - 8,0
39003.55.11	3/8"	15,0	2,0 - 6,0
39004.55.17	3/8"	15,0	2,0 - 6,0
39005.55.11	1/2"	13,0	6,0 - 12,0
39006.55.17	1/2"	13,0	6,0 - 12,0
39007.55.11	1/2"	13,0	5,0 - 9,0
39008.55.17	1/2"	13,0	5,0 - 9,0

P/N	FILETTO Thread	DIMENSIONI Sizes	
		LUNGH. FILETTO Thread Length	Ø Cavo Cable Min - Max
39009.55.11	3/4"	15,0	13,0 - 18,0
39010.55.17	3/4"	15,0	13,0 - 18,0
39011.55.11	3/4"	15,0	9,0 - 16,0
39012.55.17	3/4"	15,0	9,0 - 16,0
39013.55.11	1"	16,0	18,0 - 25,0
39014.55.17	1"	16,0	18,0 - 25,0
39015.55.11	1"	16,0	13,0 - 20,0
39016.55.17	1"	16,0	13,0 - 20,0

MATERIALE | MATERIAL: Nylon 66 | PA 66

COLORI STANDARD | STANDARD COLOURS: Grigio - Nero | Grey - Black

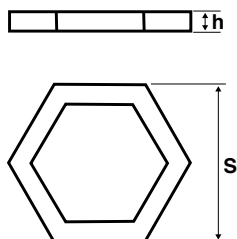

P/N	FILETTO Thread	DIMENSIONI Sizes	
		S	h

FILETTO PG | PG thread

40001.55.11	PG 7	18,0 - 19,0	5,0
40002.55.17	PG 7	18,0 - 19,0	5,0
40003.55.11	PG 9	22,0	5,0
40004.55.17	PG 9	22,0	5,0
40005.55.11	PG 11	24,0	5,0
40006.55.17	PG 11	24,0	5,0
40007.55.11	PG 13,5	27,0	5,5
40008.55.17	PG 13,5	27,0	5,5
40009.55.11	PG 16	30,0	5,5
40010.55.17	PG 16	30,0	5,5
40011.55.11	PG 21	36,0	6,0
40012.55.17	PG 21	36,0	6,0
40013.55.11	PG 29	46,0	7,0
40014.55.17	PG 29	46,0	7,0
40015.55.11	PG 36	59,0 - 60,0	8,0
40016.55.17	PG 36	59,0 - 60,0	8,0
40017.55.11	PG 42	63,0 - 65,0	8,0
40018.55.17	PG 42	63,0 - 65,0	8,0
40019.55.11	PG 48	69,0 - 70,0	8,0
40020.55.17	PG 48	69,0 - 70,0	8,0

P/N	FILETTO Thread	DIMENSIONI Sizes	
		S	h

FILETTO METRICO | Metric thread

40021.55.11	M12 x 1,5	19,0	5,0
40022.55.17	M12 x 1,5	19,0	5,0
40023.55.11	M16 x 1,5	22,0	5,0
40024.55.17	M16 x 1,5	22,0	5,0
40025.55.11	M20 x 1,5	27,0	5,5
40026.55.17	M20 x 1,5	27,0	5,5
40027.55.11	M25 x 1,5	33,0	6,5
40028.55.17	M25 x 1,5	33,0	6,5
40029.55.11	M32 x 1,5	39,0 - 42,0	8,0
40030.55.17	M32 x 1,5	39,0 - 42,0	8,0
40031.55.11	M40 x 1,5	50,0 - 52,0	7,0
40032.55.17	M40 x 1,5	50,0 - 52,0	7,0
40033.55.11	M50 x 1,5	63,0 - 65,0	8,0
40034.55.17	M50 x 1,5	63,0 - 65,0	8,0
40035.55.11	M60 x 1,5	75,0	8,0
40036.55.17	M60 x 1,5	75,0	8,0

FILETTO NPT | NPT thread

40037.55.11	3/8"	24,0	5,0
40038.55.17	3/8"	24,0	5,0
40039.55.11	1/2"	27,0	7,0
40040.55.17	1/2"	27,0	7,0
40041.55.11	3/4"	33,0	7,0
40042.55.17	3/4"	33,0	7,0
40043.55.11	1"	47,0	7,0
40044.55.17	1"	47,0	7,0

